

Features

- Single-speed whirlpool offers performance and value, with 8 fully adjustable jets.
- Hydromassage flow and direction can be controlled at each jet.
- Comfort Depth® design offers a convenient 19-inch step-over height while retaining the same depth as a standard 21-inch bath.
- Molded lumbar support offers extra comfort while bathing.
- Slotted overflow allows for deep soaking.
- Textured bottom surface
- Reversible drain.
- Coordinates with other products in the Archer collection.

Material

- Acrylic

Hydrotherapy

- Whirlpool

Installation

- Drop-in

Additional Hydrotherapy Options

- Soaking Bath - K-1123-0
- Soaking Bath + Bask heated surface - K-1123-W1
- BubbleMassage air bath - K-1122-G
- BubbleMassage air bath + Bask heated surface - K-1122-GW
- VibrAcoustic - K-1122-VB
- VibrAcoustic + Bask heated surface - K-1122-VBW
- Whirlpool - K-1122-0
- Whirlpool + heater - K-1122-H
- Whirlpool + Bask heated surface - K-1122-W1
- Whirlpool + BubbleMassage air bath - K-1122-XHG

Required Products/Accessories

K-7271 Brass Slotted Overflow Bath Drain

or

K-7272 PVC Slotted Overflow Bath Drain

Recommended Products/Accessories

K-24916 Wireless Music Kit
 K-1491 Bath/Whirlpool Pillow
 K-1601 Bath/Whirlpool Footstop
 K-702200-G54 Frameless Sliding Bath Door
 K-702200-G73 Frameless Sliding Bath Door
 K-702200-L Frameless Sliding Bath Door
 K-702205-L Frameless Sliding Bath Door
 K-706000-D3 Frameless Sliding Bath Door
 K-706000-L Frameless Sliding Bath Door
 K-706003-L Frameless Sliding Bath Door
 K-706004-D3 Frameless Sliding Bath Door



ADA

Codes/Standards











ASME A112.19.7/CSA B45.10
 CSA B45.5/IAPMO Z124
 UL 1795
 ADA
 ICC/ANSI A117.1

**KOHLER® Plastic Baths and Receptors
 Lifetime Limited Warranty
 KOHLER® Hydrotherapy Components
 Five-Year Limited Warranty**

See website for detailed warranty information.

Available Colors/Finishes

Color tiles intended for reference only.

Color	Code	Description
	0	White
	96	Biscuit
	47	Almond
	NY	Dune
	95	Ice™ Grey
	G9	Sandbar
	33	Mexican Sand™
	K4	Cashmere
	58	Thunder™ Grey
	7	Black Black™

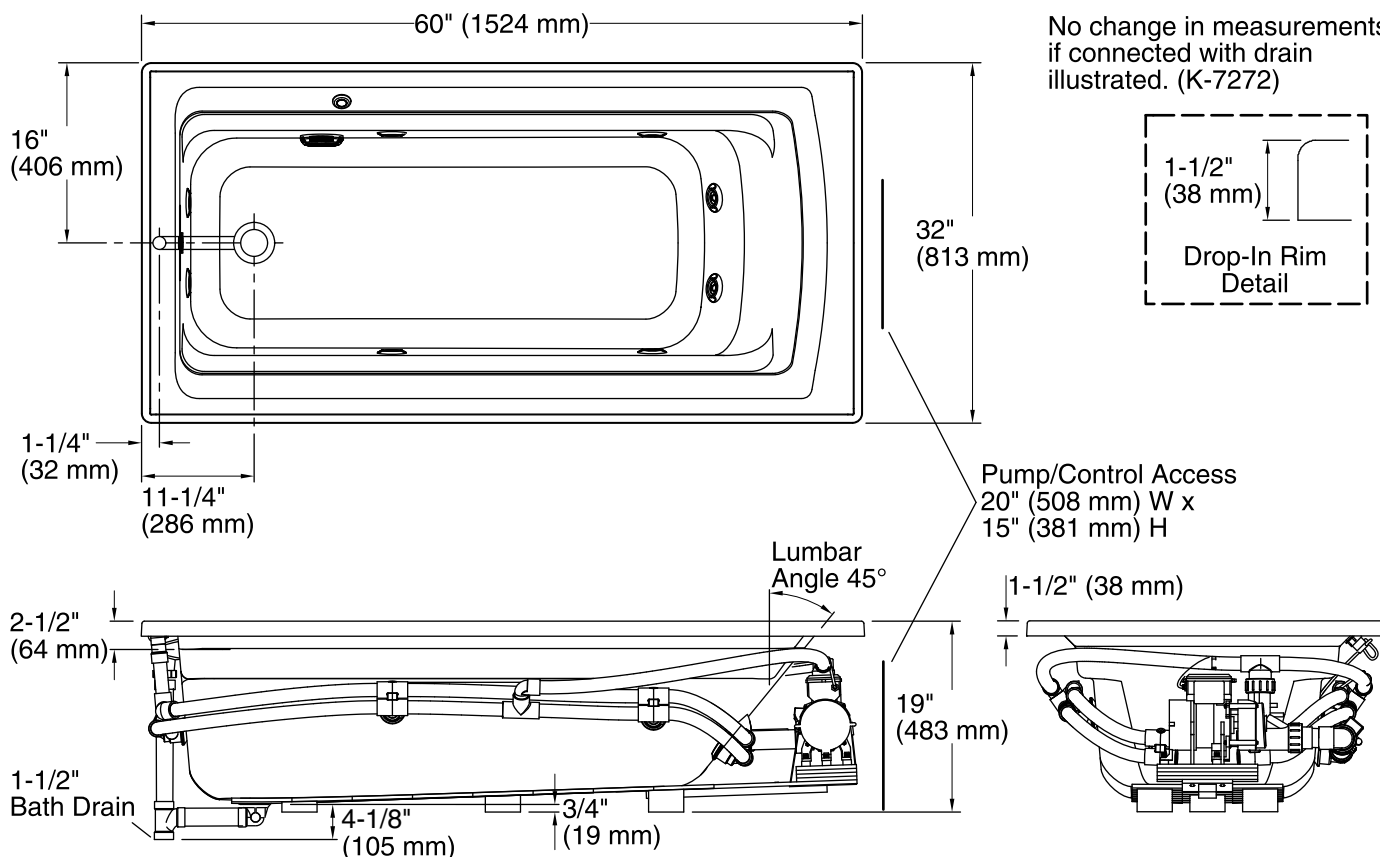

Required Electrical Service

One dedicated circuit required, protected with Class A Ground-Fault Circuit-Interrupter (GFCI). Outside North America, this device may be known as a Residual Current Device (RCD).

Pump: 120 V, 15 A, 60 Hz

Technical Information

All product dimensions are nominal.

Installation:	Drop-in
Drain location:	End
Basin area, bottom:	45-1/8" x 19-11/16" (1146 mm x 500 mm)
Basin area, top:	52-3/4" x 25-5/16" (1340 mm x 643 mm)
Weight:	110 lbs (49.9 kg)
Minimum floor load:	46 lbs/ft ² (224.6 kg/m ²)
Water depth:	15" (381 mm)
Water capacity:	58 gal (219.6 L)
Cutout:	Drop-in, 58-1/2" x 30-1/2" (1486 mm x 775 mm)
Electrical component rating:	Pump: 120 V, 7 A, 60 Hz
Pump speed:	Single
Minimum flat for door:	2-3/16" (56 mm)

Notes

Measure your actual product for rough-in details. Install this product according to the installation instructions.

The hot water supply should be 70% of the capacity of the bath or greater. Installations will vary.

Provide one grounded electrical outlet within 24" (610 mm) of each component.

This product is designed for drop-in installation only. It is not suited for use in a three-wall alcove with an overhead shower.

ADA compliant when installed to the specific requirements of these regulations.